

# COASTLINE COLLEGE

2018 – 2019

## ORGANIZATIONAL CHARTS

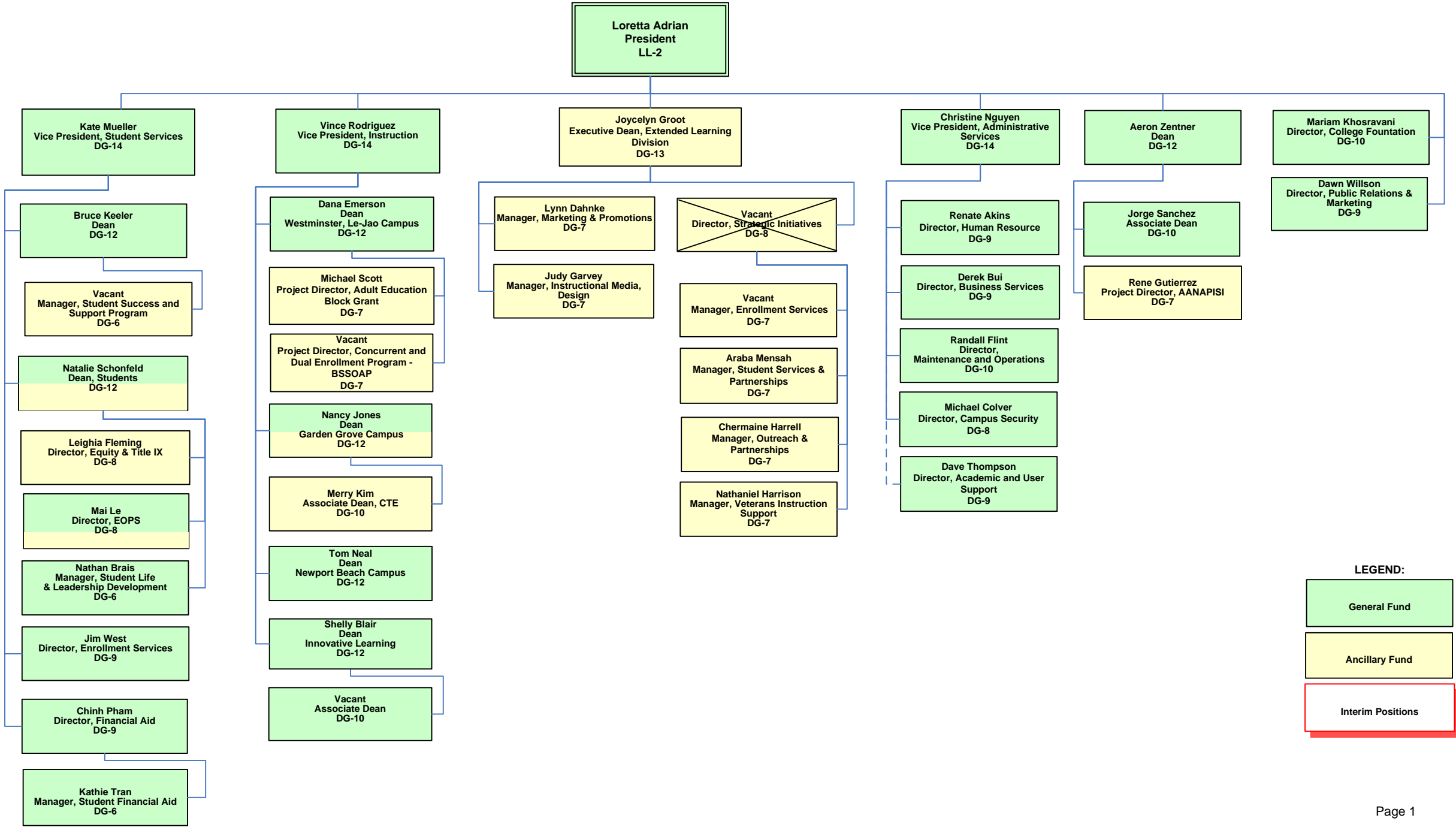

**LEGEND:**

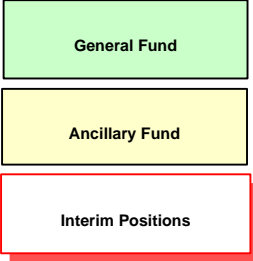

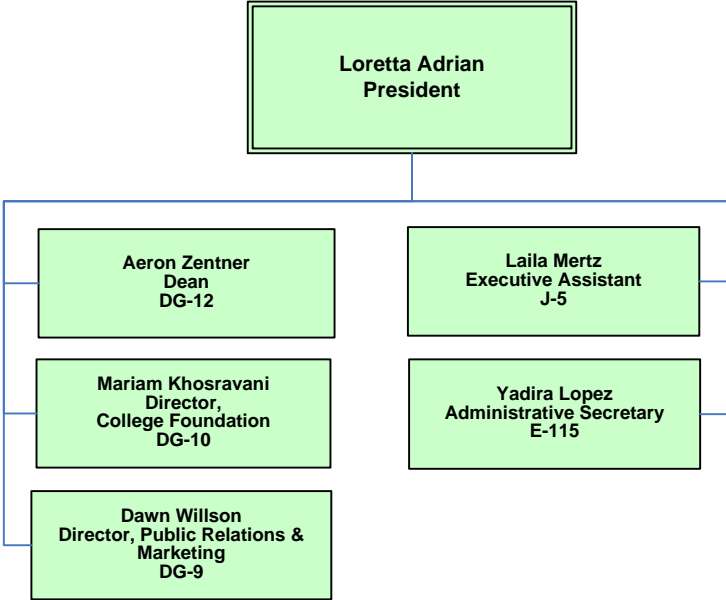

LEGEND:

General Fund

Ancillary Fund/Grant

Interim Positions

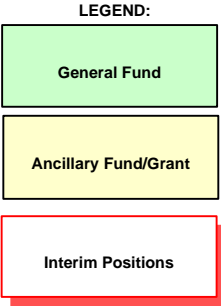
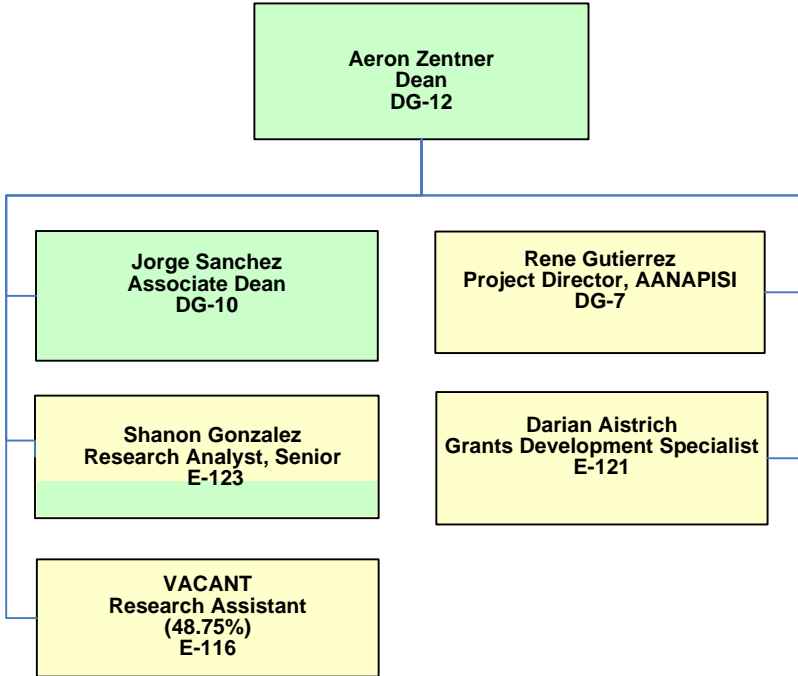

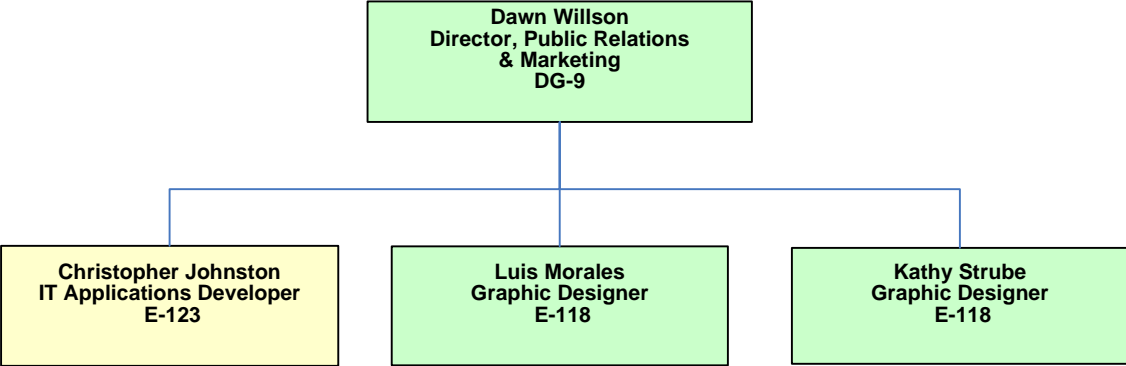

**LEGEND:**

- General Fund
- Ancillary Fund/Grant
- Interim Positions

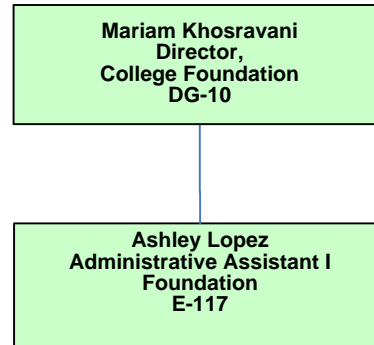

**LEGEND:**

General Fund

Ancillary Fund/Grant

Interim Positions

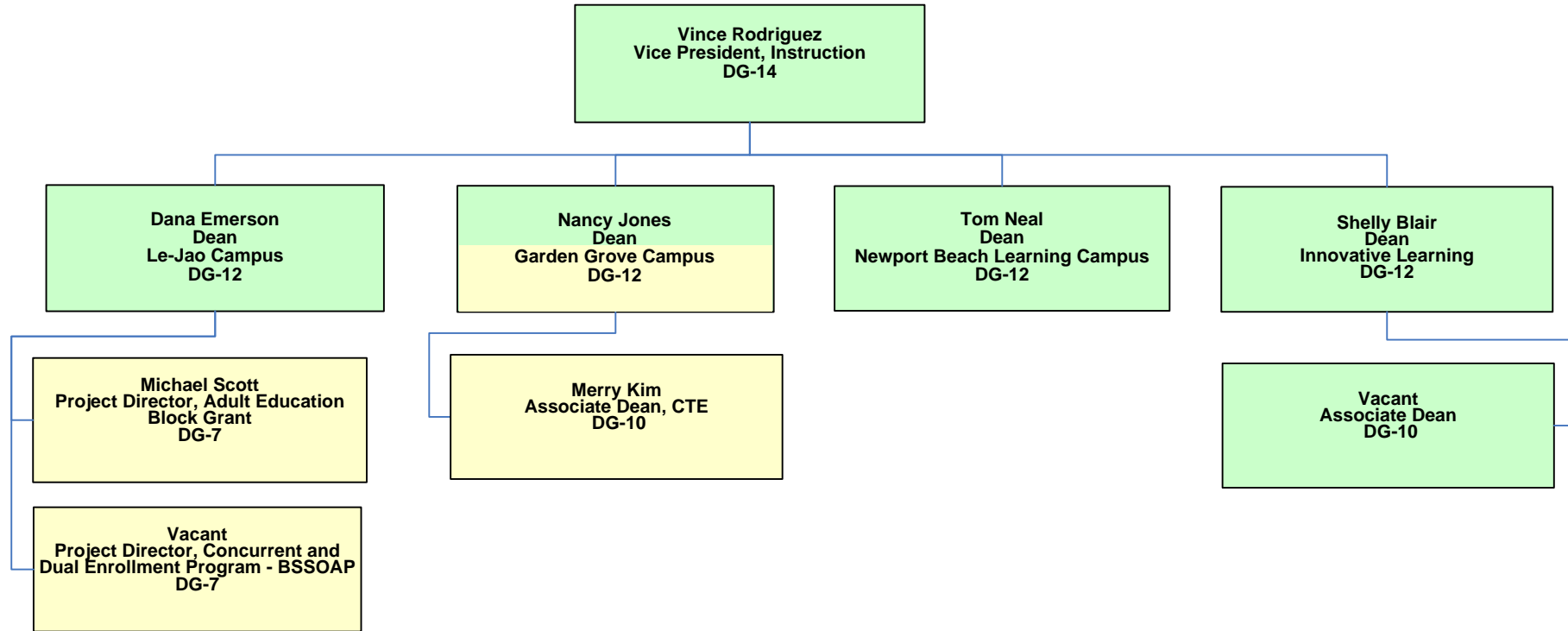

LEGEND:

General Fund

Ancillary Fund/Grant

Interim Positions

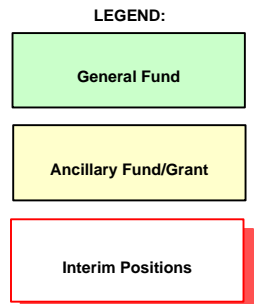
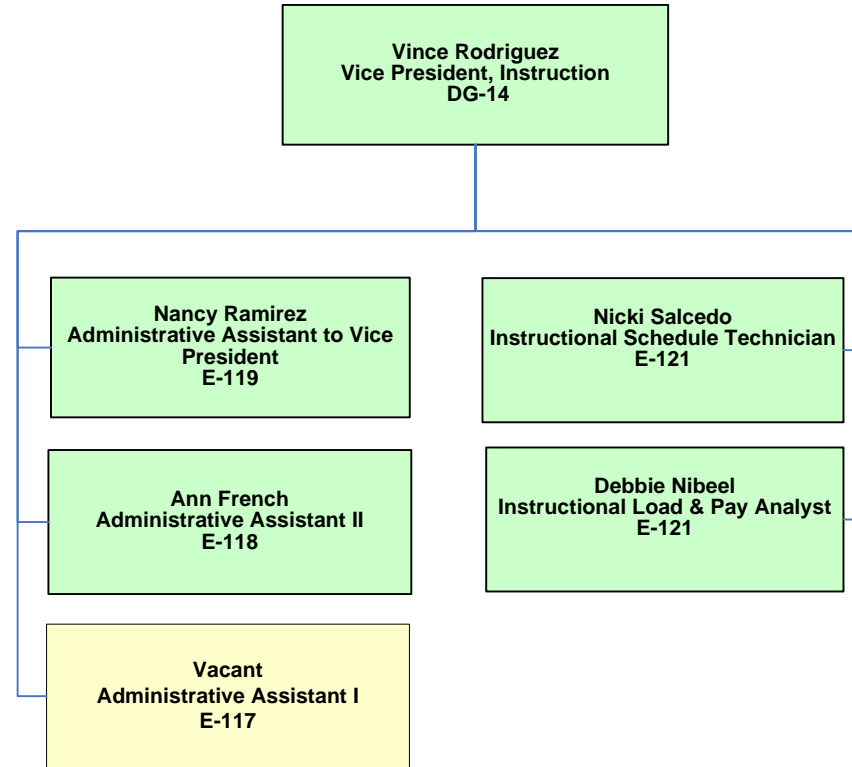



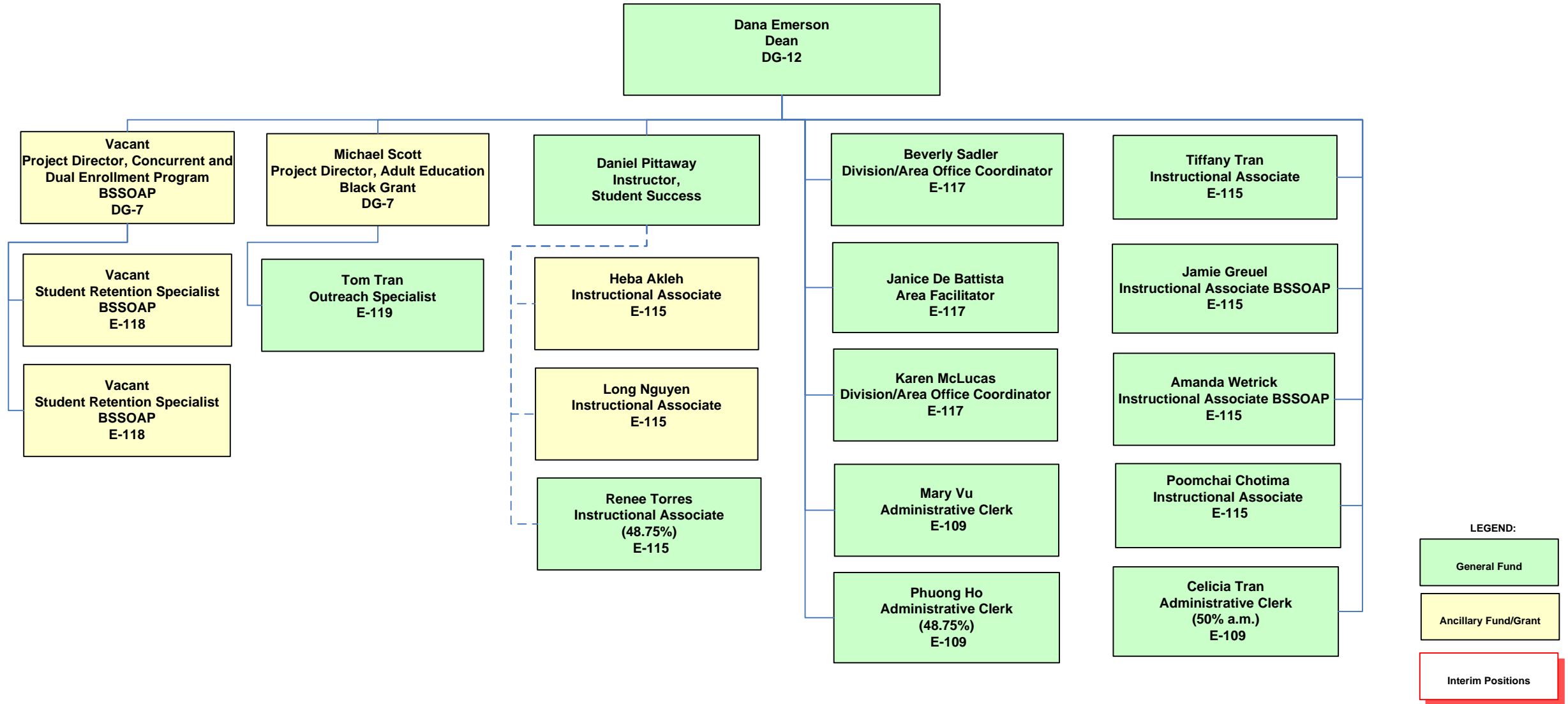

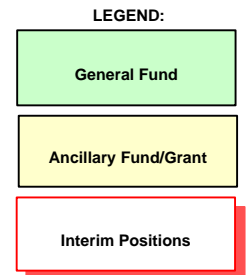
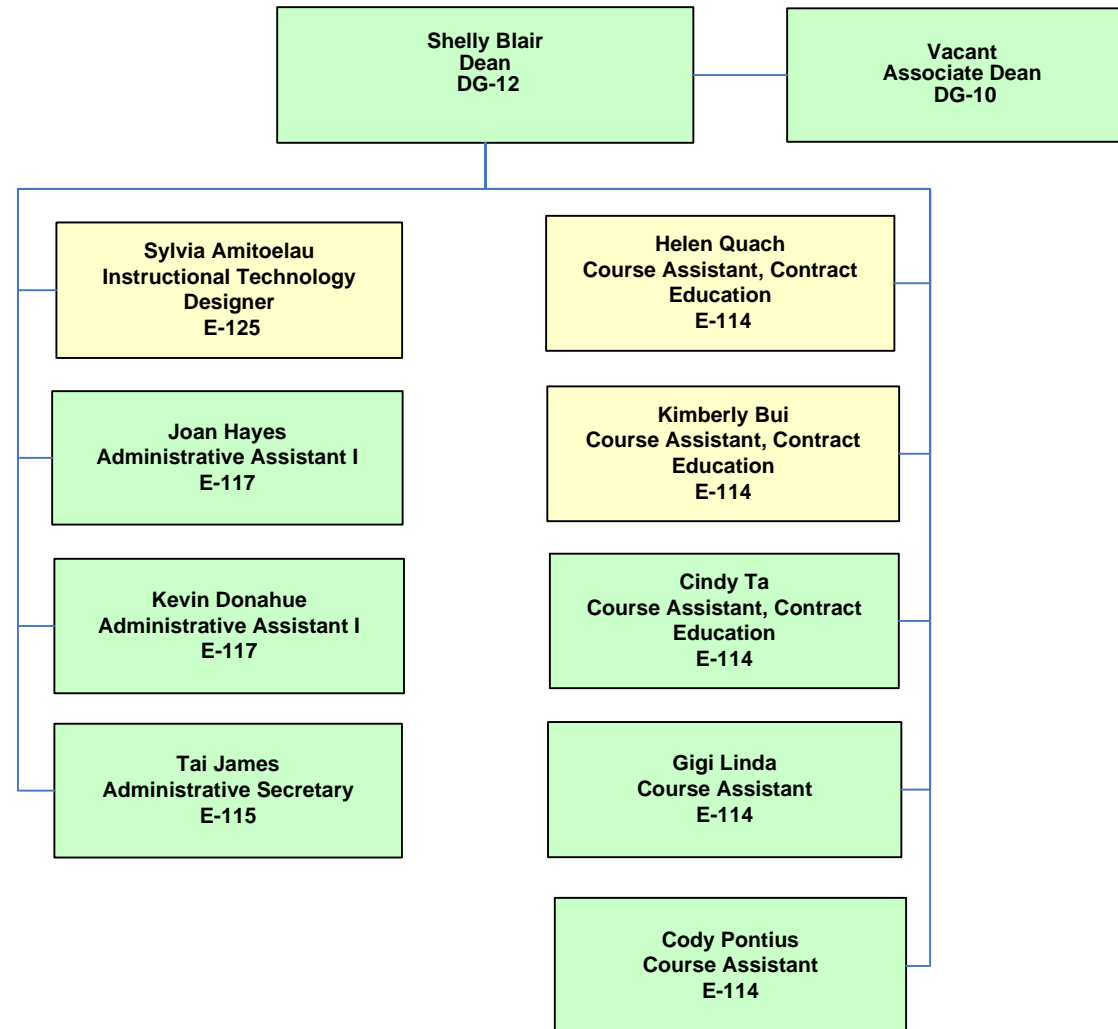

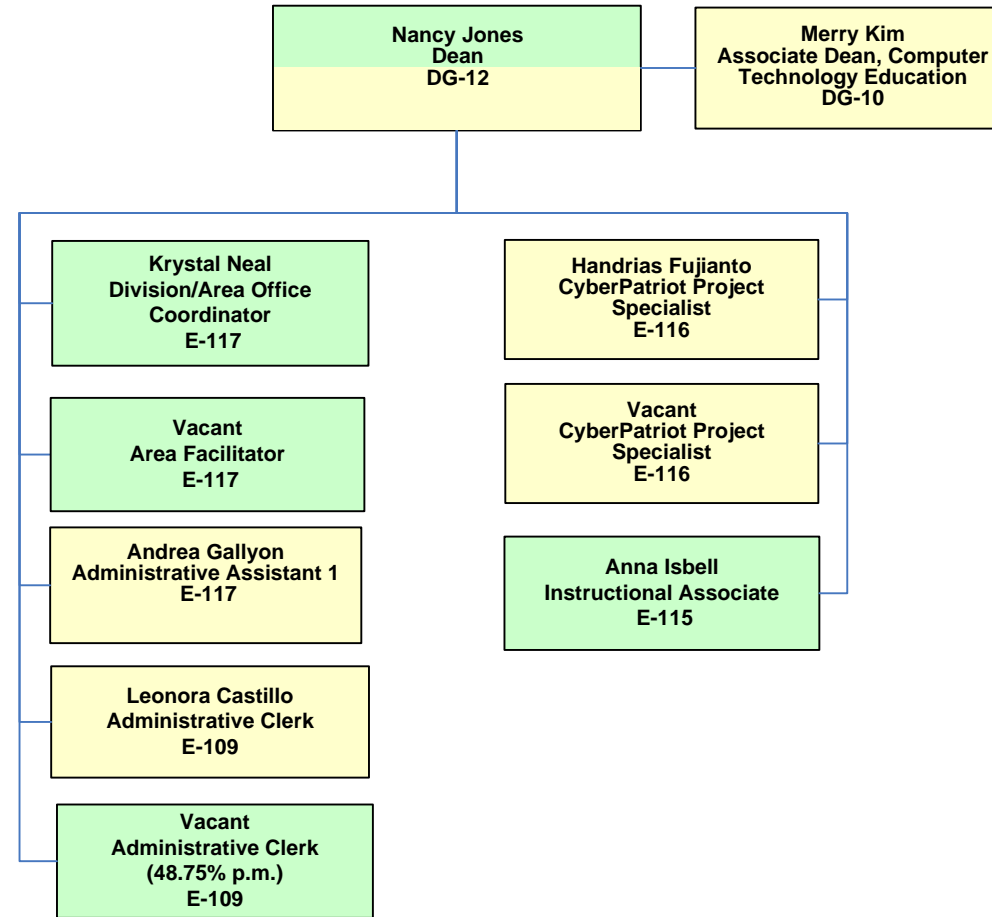

LEGEND:

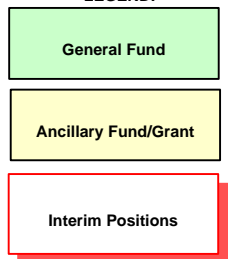

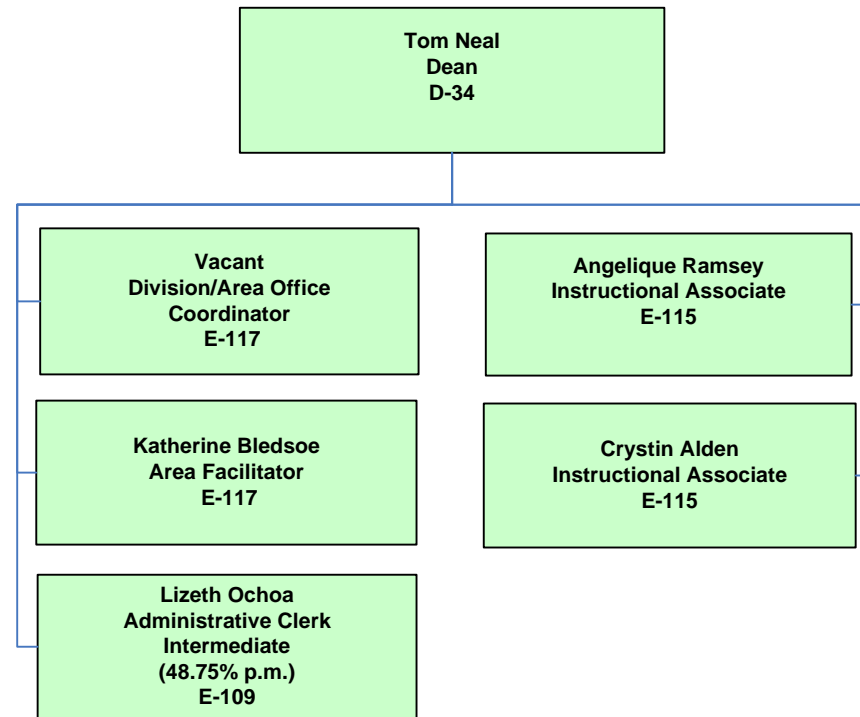

LEGEND:

General Fund

Ancillary Fund/Grant

Interim Positions

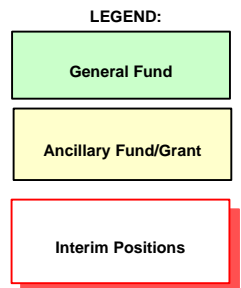
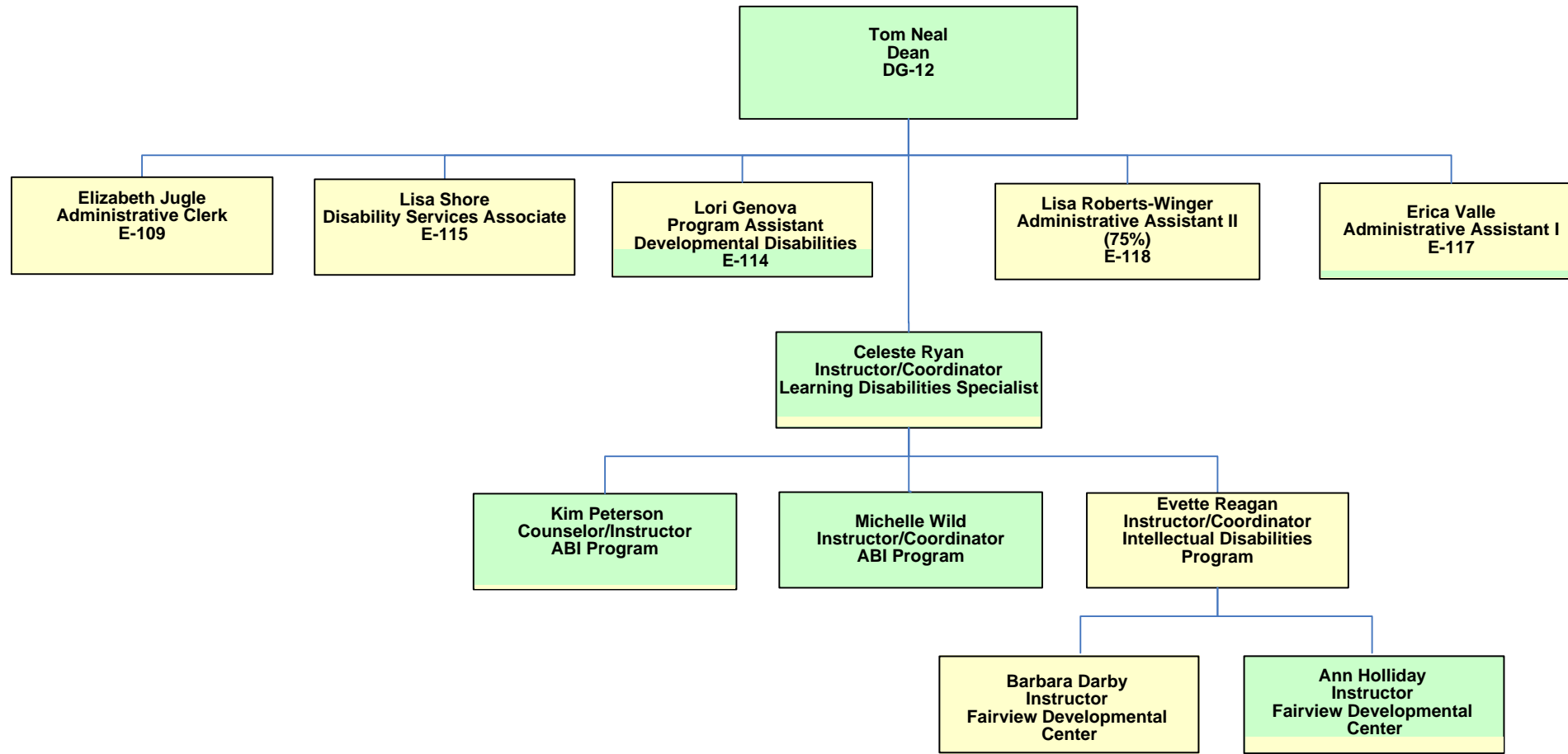

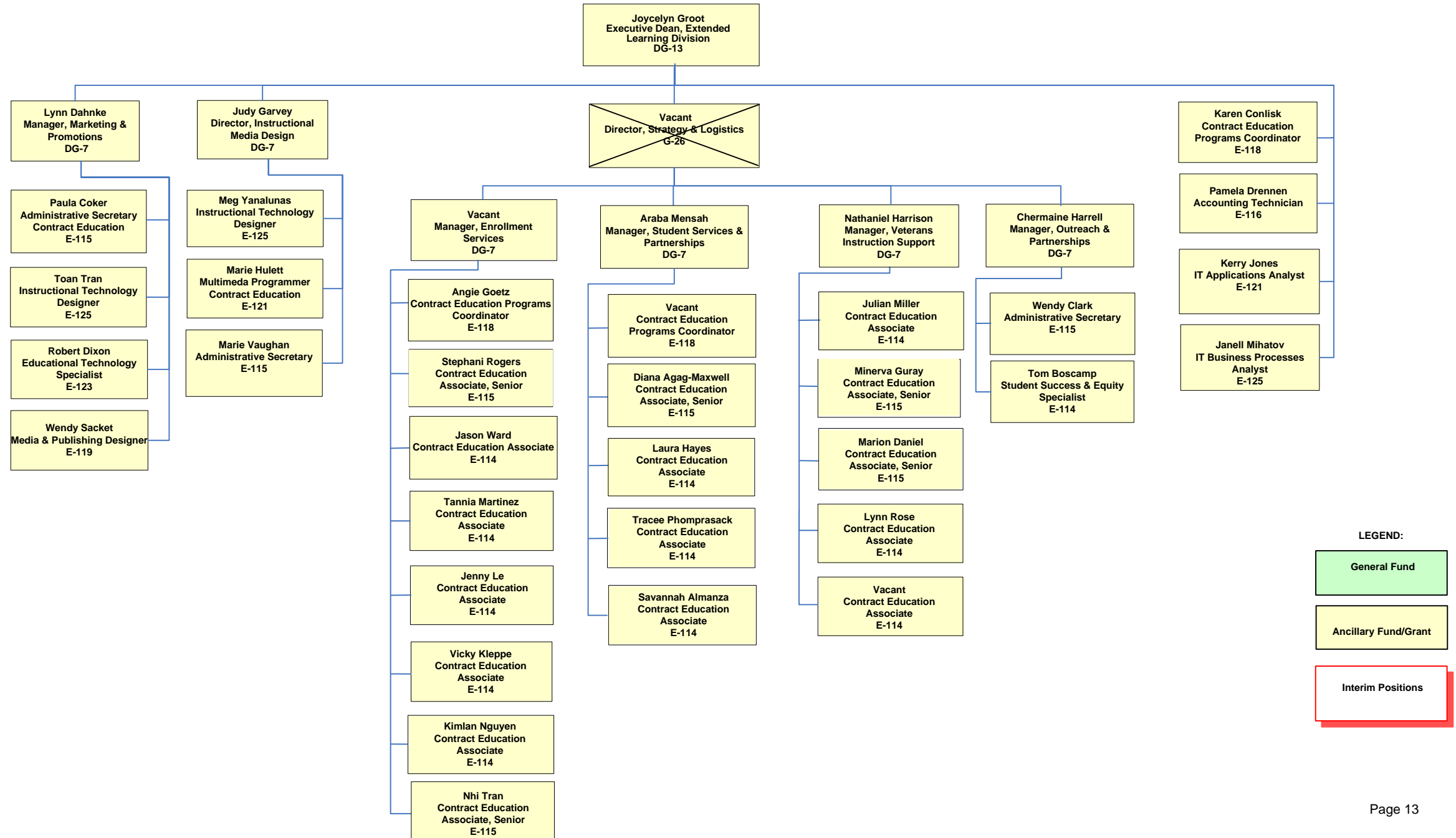

LEGEND:

- General Fund
- Ancillary Fund/Grant
- Interim Positions

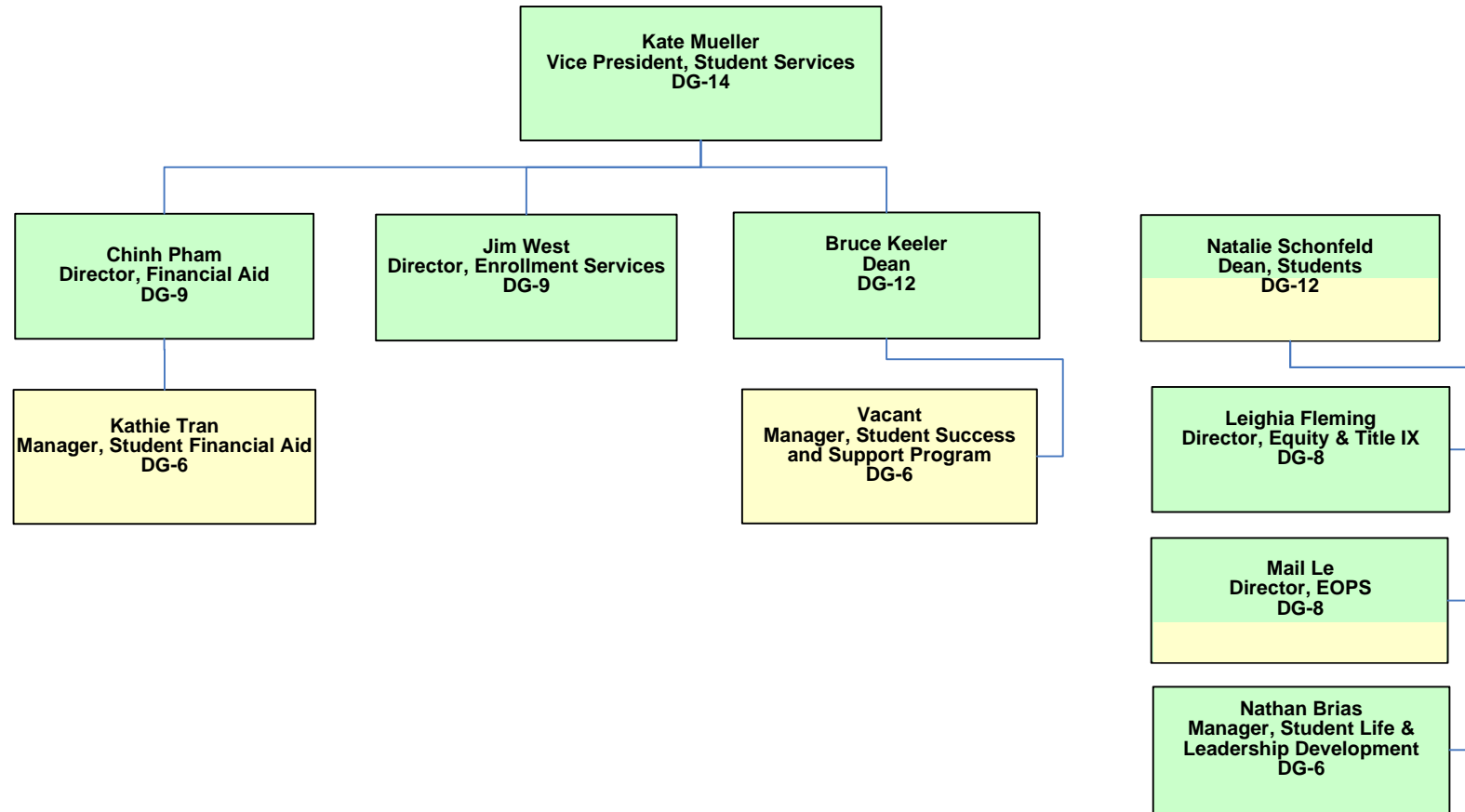

LEGEND:

General Fund

Ancillary Fund/Grant

Interim Positions

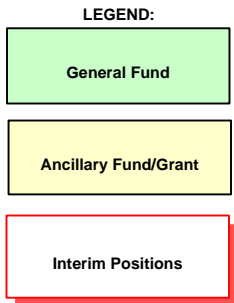
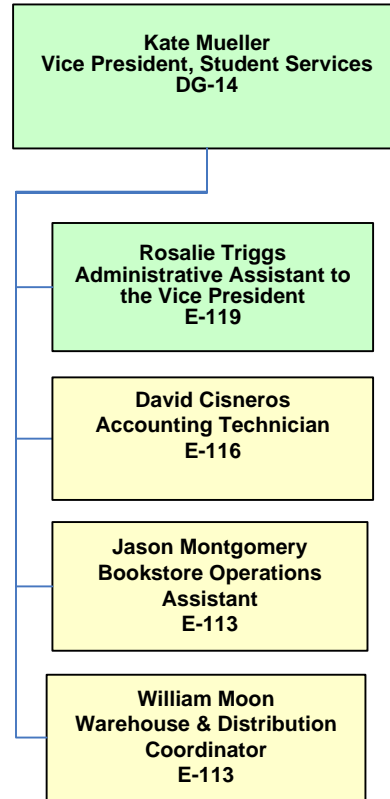



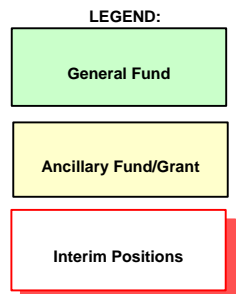
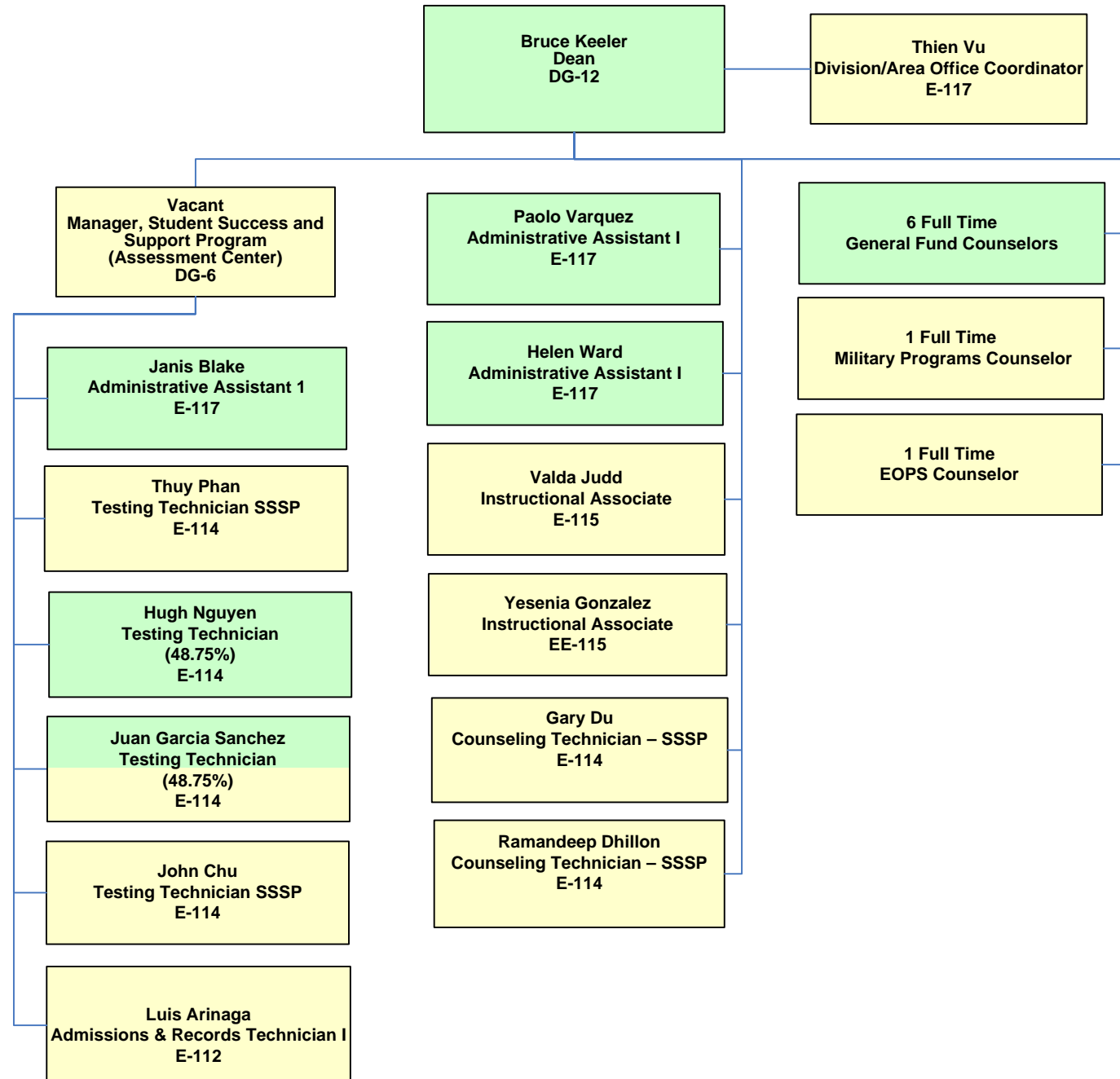

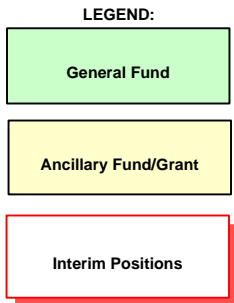
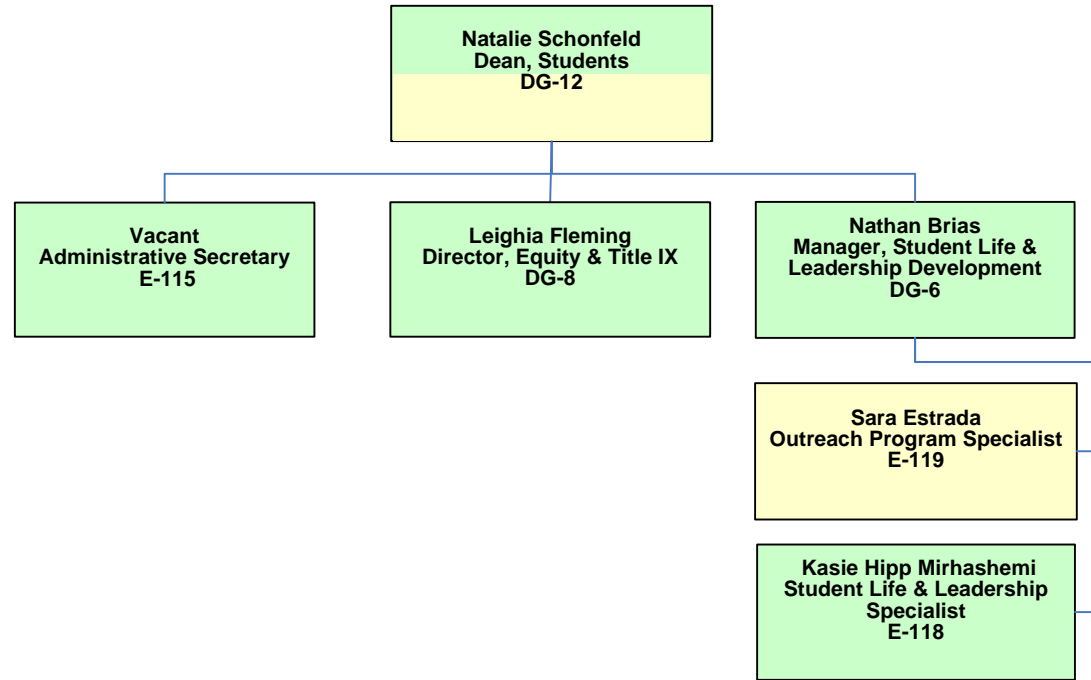

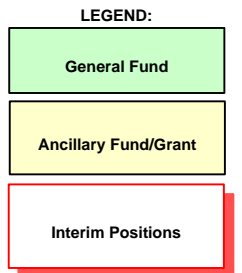
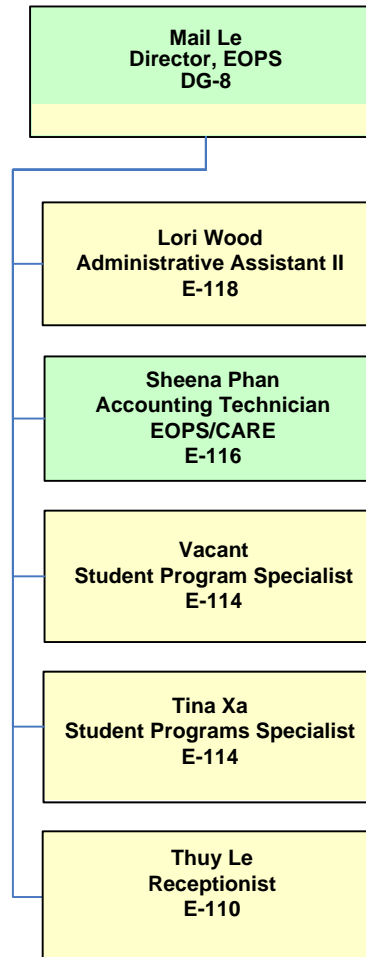

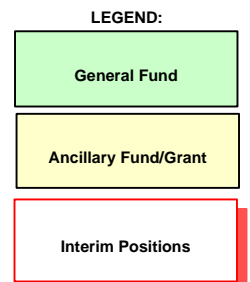
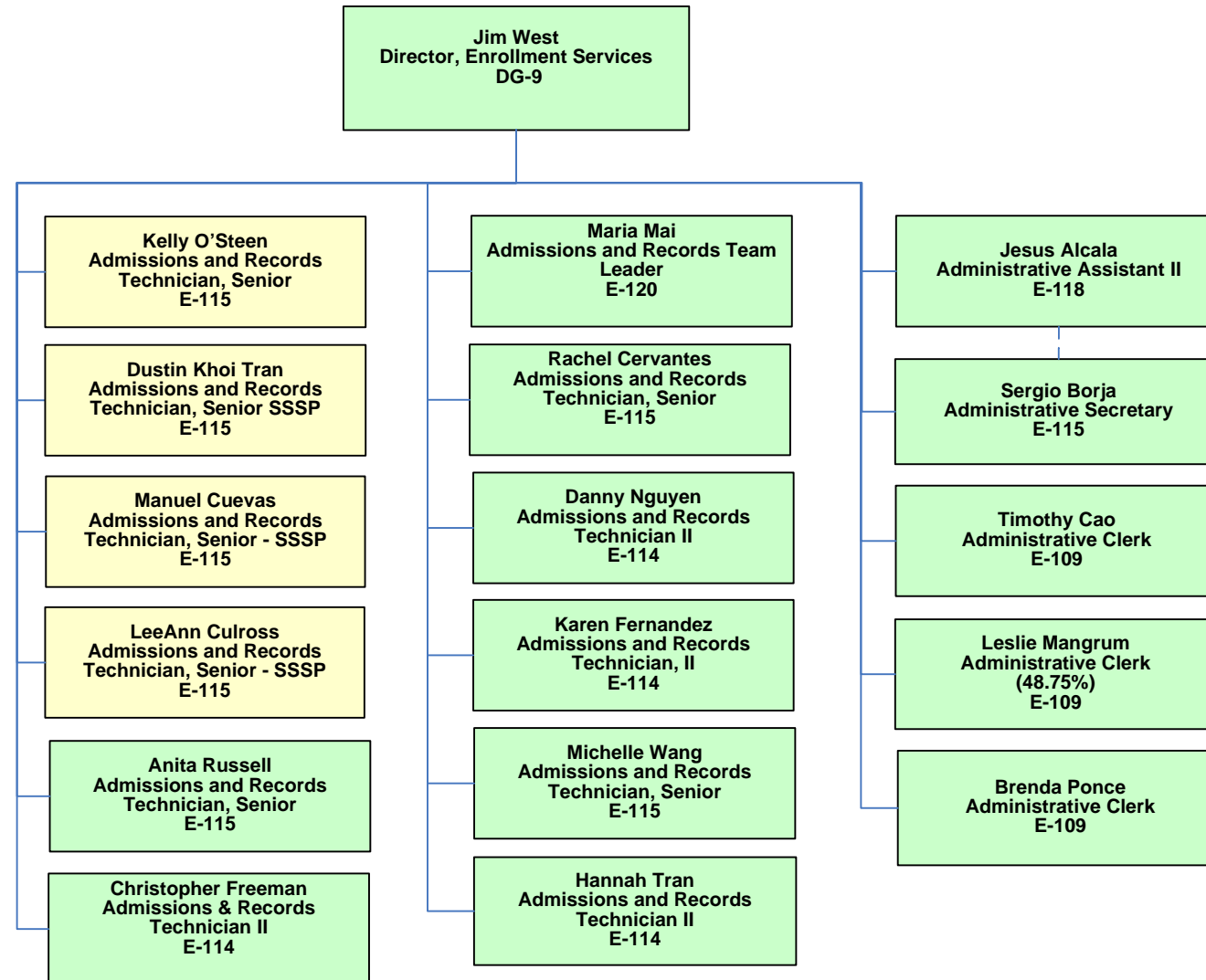

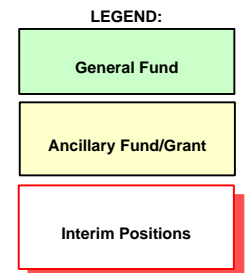
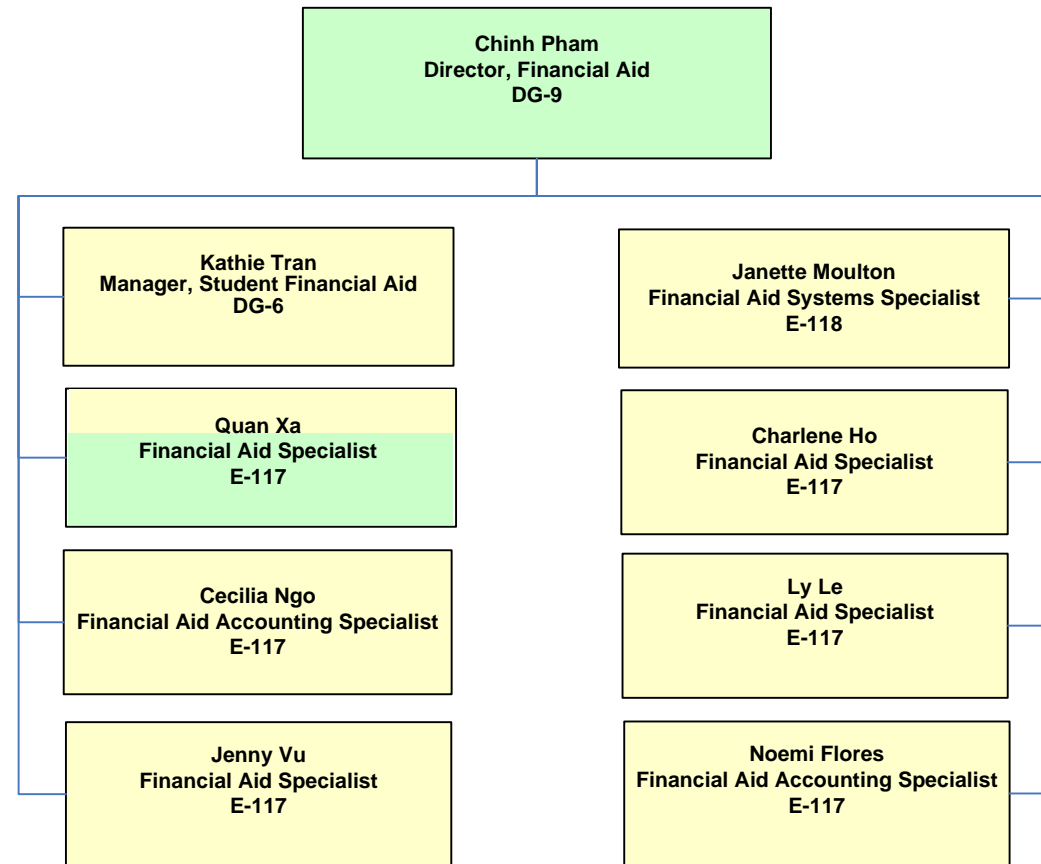

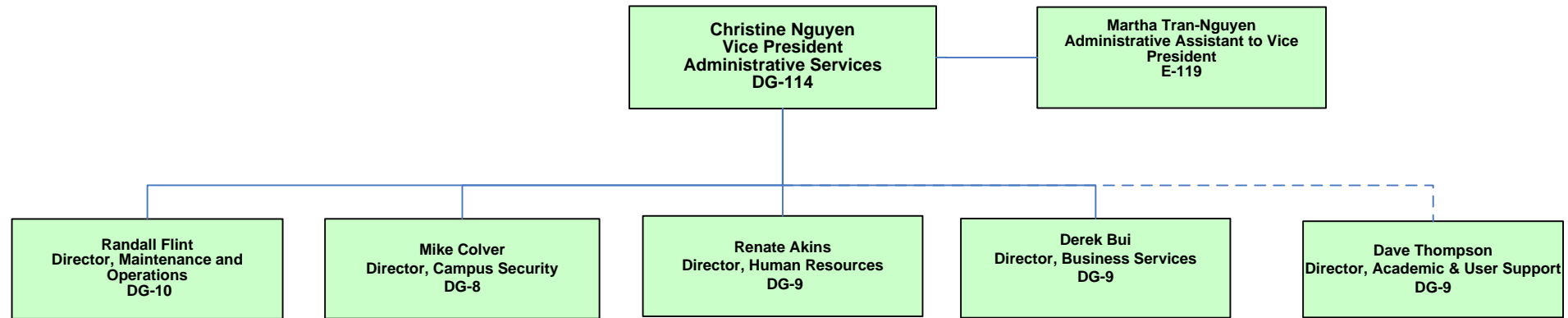

LEGEND:

General Fund

Ancillary Fund/Grant

Interim Positions

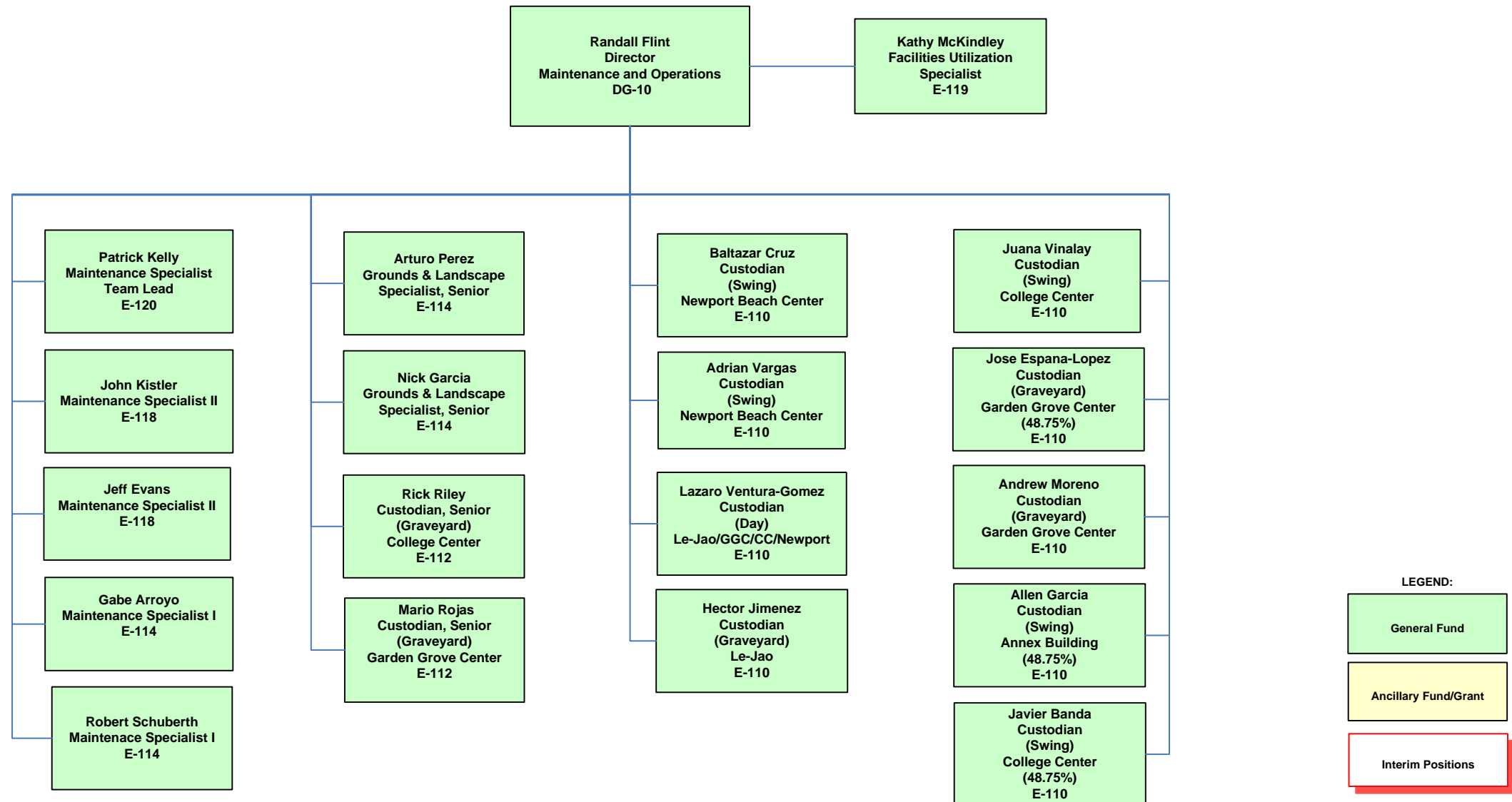

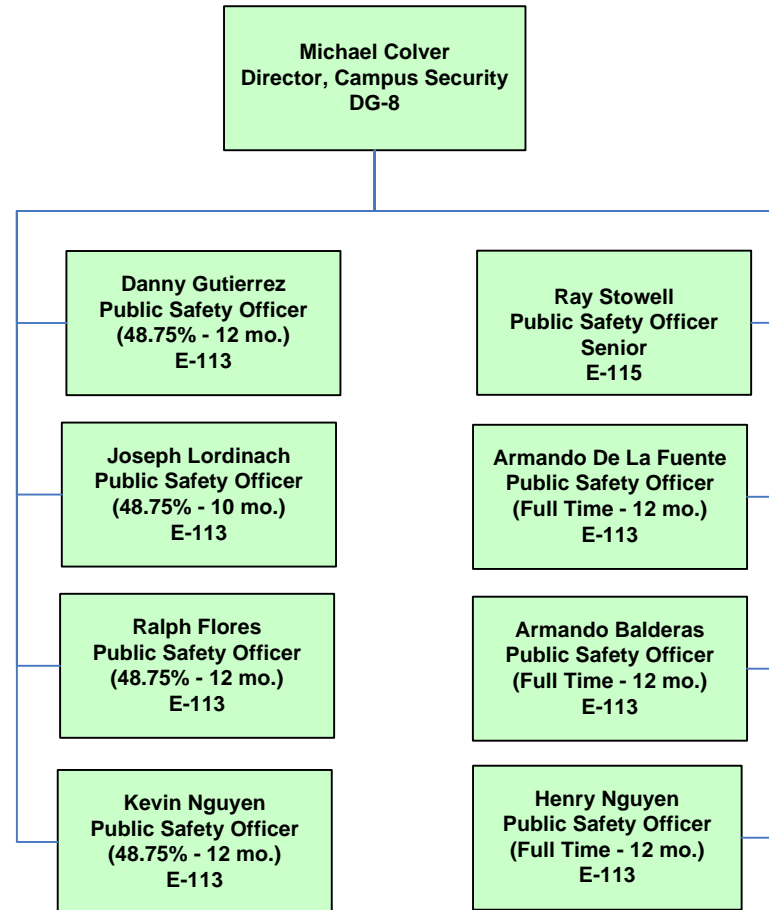

LEGEND:

General Fund

Ancillary Fund/Grant

Interim Positions



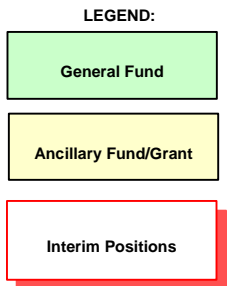
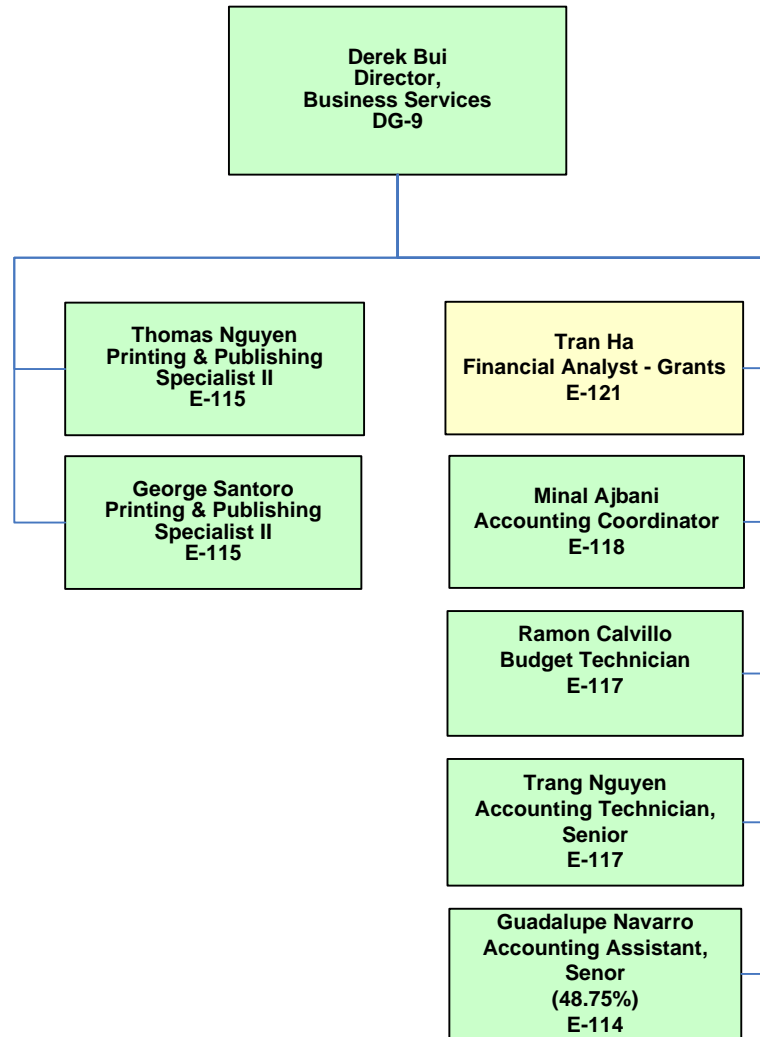

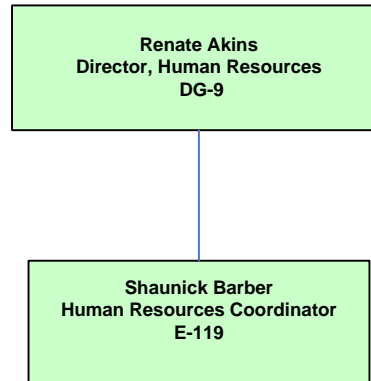

**LEGEND:**

General Fund

Ancillary Fund/Grant

Interim Positions